

LC-P1275P

FOR STANDBY POWER SUPPLIES.
EXPECTED TRICKLE DESIGN LIFE: 10 - 12 YEARS AT 20°C
ACCORDING TO EUROBAT.

DIMENSIONS (MM)

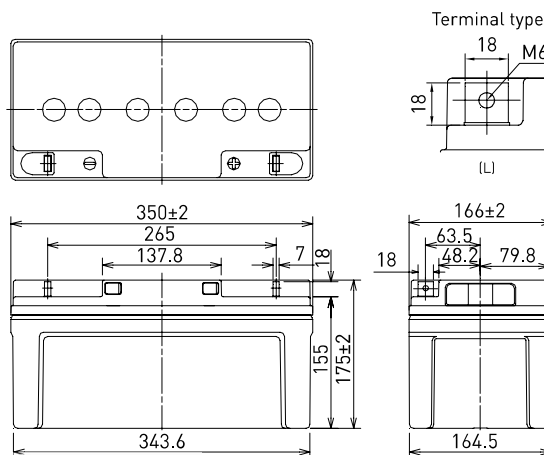

Contents indicated (including the recycle marking, etc.) are subject to change without notice.

Battery case resin: flame retardant (UL94 V-0)

SPECIFICATIONS

Name		LC-P1275P
Nominal voltage		12V
Nominal capacity (20 hour rate)		75Ah
Dimensions	Length	350mm
	Width	166mm
	Height	175mm
Approx. mass		21.5kg
Terminal		M6 bolt/nut
Capacity (25°C)	20 hour rate	75Ah
	10 hour rate	70Ah
	3 hour rate	53Ah
	1 hour rate	50Ah
Impedance		Fully charged battery (25°C) 7mΩ
Temperature dependency of capacity (20 hour rate)	40°C	102%
	25°C	100%
	0°C	85%
	-15°C	65%
Self-discharge (25°C)	After 3 month	91%
	After 6 month	82%
	After 12 month	64%

DURATION OF DISCHARGE VS. DISCHARGE CURRENT

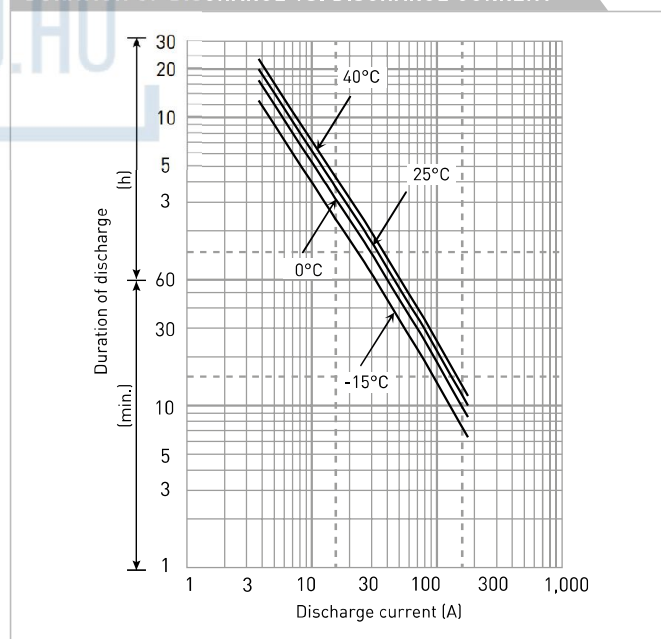

WATT TABLE (25°C)

(Wattage/battery)

Cut-off	5min.	10min.	15min.	20min.	30min.	45min.	1h	1.5h	2h	3h	4h	5h	6h	10h	20h
9.6V	2,273	1,985	1,546	1,313	962	702	555	411	327	220	171	149	125	79.5	45.0
9.9V	2,233	1,950	1,538	1,306	955	683	553	403	325	216	169	147	124	79.1	45.0
10.2V	2,093	1,827	1,531	1,290	940	679	549	400	321	215	168	146	123	78.6	45.0
10.5V	1,875	1,637	1,446	1,230	925	671	546	395	317	210	166	144	122	78.2	45.0
10.8V	1,657	1,447	1,400	1,200	911	580	473	355	301	205	164	143	120	77.8	44.1

AMPERE TABLE (25°C)

(Ampere/battery)

Cut-off	5min.	10min.	15min.	20min.	30min.	45min.	1h	1.5h	2h	3h	4h	5h	6h	10h	20h
9.6V	241	177	134	116	86.9	61.5	51.0	34.8	27.6	18.5	14.3	12.4	10.4	7.14	3.75
9.9V	237	175	132	113	86.3	59.9	50.8	34.1	27.4	18.2	14.2	12.2	10.3	7.11	3.75
10.2V	222	167	130	111	84.9	59.5	50.5	33.8	27.1	18.1	14.0	12.1	10.2	7.07	3.75
10.5V	199	159	126	109	83.6	58.9	50.2	33.4	26.8	17.7	13.9	12.0	10.1	7.04	3.75
10.8V	176	151	122	106	82.3	50.8	43.5	30.1	25.4	17.3	13.7	11.9	10.0	7.00	3.68

All mentioned values are average values

LC-P1275P

CHARGING METHOD (25°C)

Trickle use Control voltage: 13.6V - 13.8V
Initial current: 11.3A or smaller

CUT-OFF VOLTAGE

Discharge current	3.75A - 15.0A	15.0A - 37.5A	37.5A - 75.0A	75.0A - 150A	150A - 225A
Cut-off voltage	10.5V	10.2V	9.9V	9.3V	8.7V

INFLUENCE OF TEMPERATURE ON TRICKLE LIFE

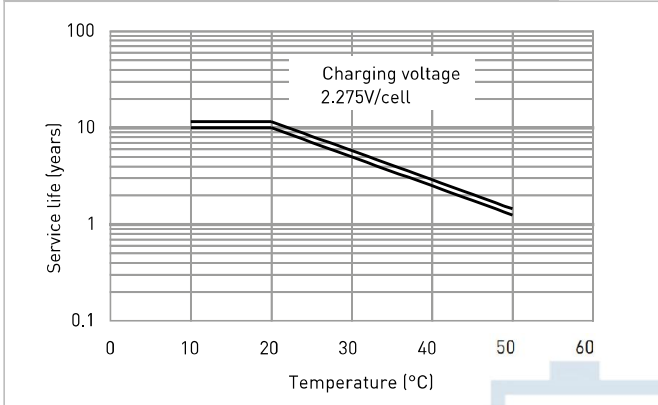

RESIDUAL CAPACITY TEST RESULT

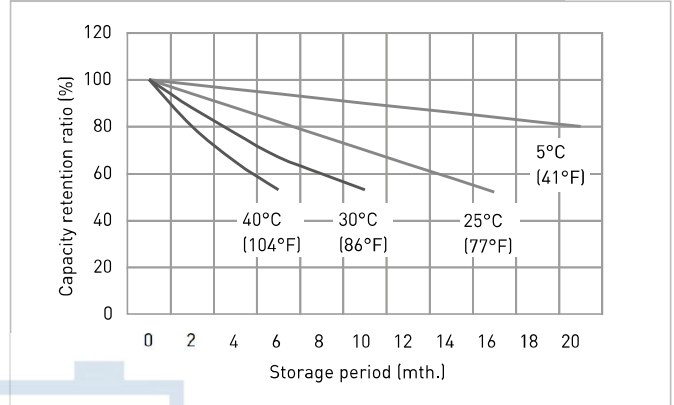

CONSTANT-VOLTAGE CONSTANT-CURRENT CHARGE CHARACTERISTICS FOR TRICKLE USE

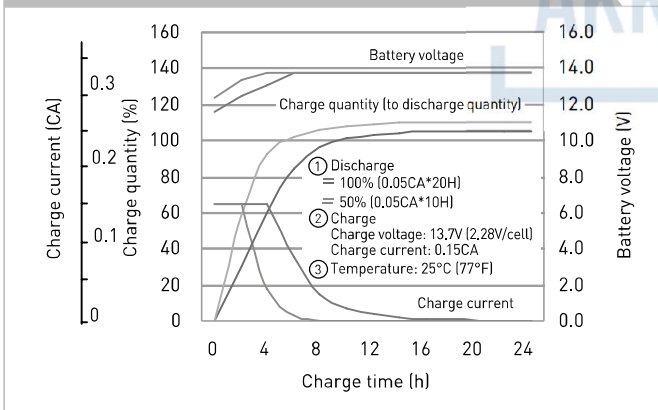

DISCHARGE CAPACITY BY TEMPERATURE AND BY DISCHARGE CURRENT

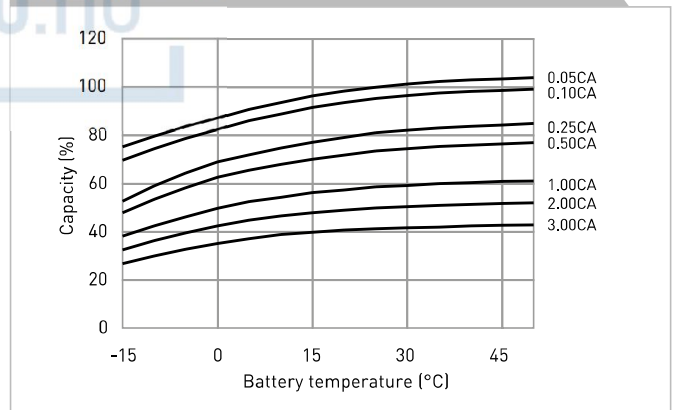

DISCHARGE CHARACTERISTICS

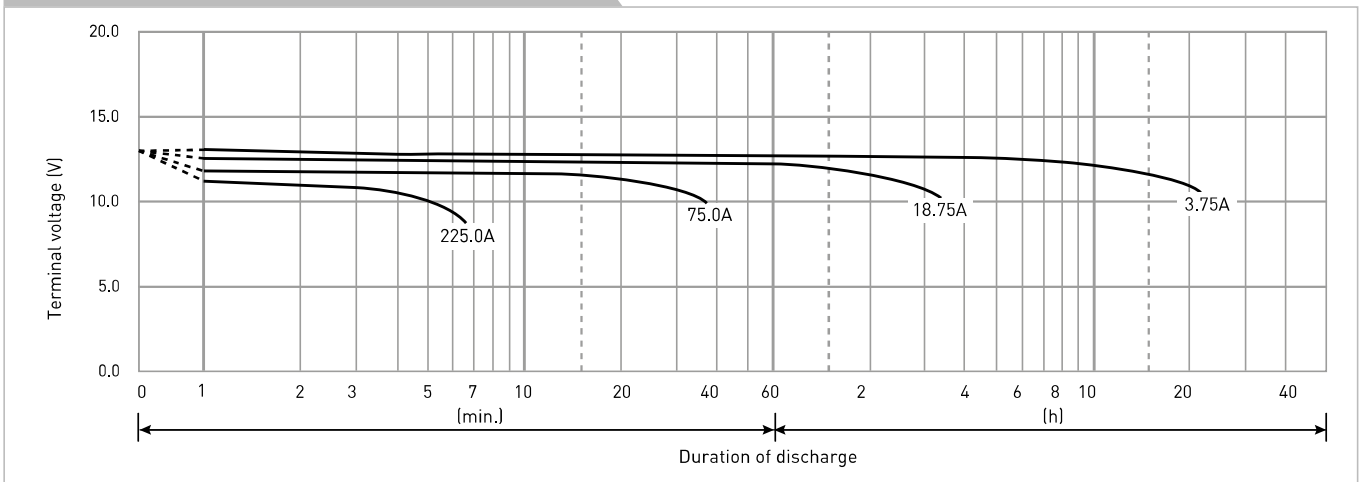

The data in this document are for descriptive purposes only and are not intended to make or imply any guarantee or warranty. Regarding handling and safety please consult our VRLA technical handbook chapter 1.