

LC-P1242P

DIMENSIONS (MM)

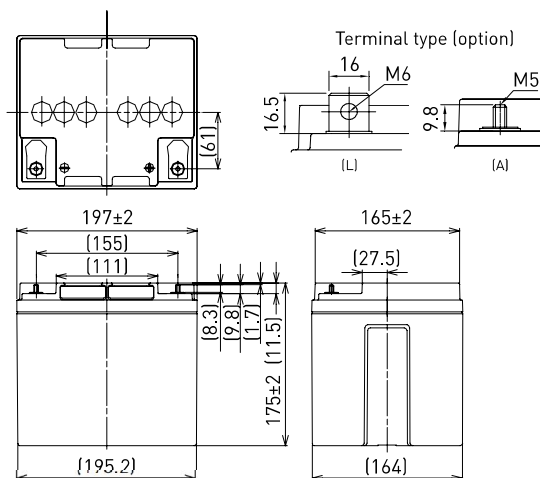

FOR STANDBY POWER SUPPLIES.
EXPECTED TRICKLE DESIGN LIFE: 10 - 12 YEARS AT 20°C
ACCORDING TO EUROBAT.



Contents indicated (including the recycle marking, etc.) are subject to change without notice.

Battery case resin: flame retardant (UL94 V-0)

SPECIFICATIONS

Name		LC-P1242P/AP
Nominal voltage		12V
Nominal capacity (20 hour rate)		42Ah
Dimensions	Length	197mm
	Width	165mm
	Height	175mm/180mm
Approx. mass		13.5kg
Terminal		M6 bolt/nut & M5 threaded post
Capacity (25°C)	20 hour rate	42Ah
	10 hour rate	40Ah
	3 hour rate	32Ah
	1 hour rate	26Ah
Impedance		Fully charged battery (25°C) 10mΩ
Temperature dependency of capacity (20 hour rate)	40°C	102%
	25°C	100%
	0°C	85%
	-15°C	65%
Self-discharge (25°C)	After 3 month	91%
	After 6 month	82%
	After 12 month	64%

DURATION OF DISCHARGE VS. DISCHARGE CURRENT

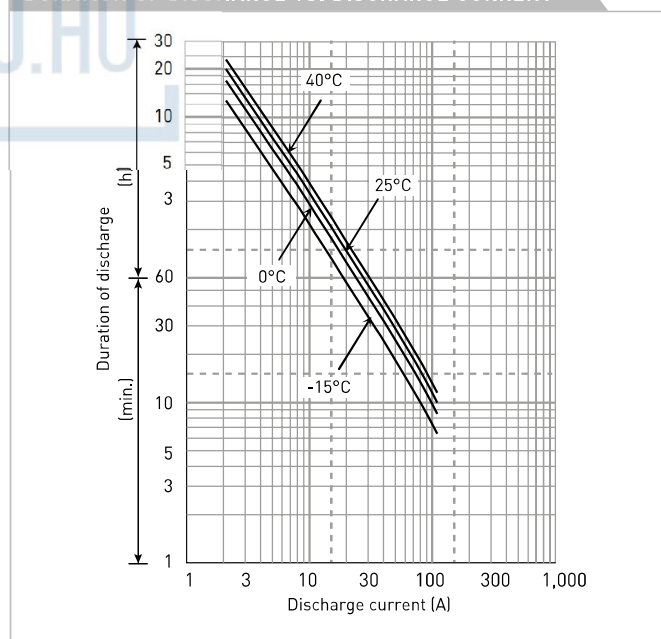

WATT TABLE (25°C)

(Wattage/battery)

Cut-off	5min.	10min.	15min.	20min.	30min.	45min.	1h	1.5h	2h	3h	4h	5h	6h	10h	20h
9.6V	1,483	1,254	966	835	625	410	312	241	187	132	110	89.9	79.1	48.0	25.2
9.9V	1,405	1,232	955	824	607	407	310	234	186	130	109	89.4	78.5	48.0	25.2
10.2V	1,327	1,210	943	812	596	406	307	217	184	127	108	88.9	77.9	48.0	25.2
10.5V	1,249	1,176	920	800	585	405	306	211	179	126	107	88.5	76.7	48.0	25.2
10.8V	1,215	1,086	886	777	573	390	295	201	173	121	105	87.5	75.5	48.0	25.2

AMPERE TABLE (25°C)

(Ampere/battery)

Cut-off	5min.	10min.	15min.	20min.	30min.	45min.	1h	1.5h	2h	3h	4h	5h	6h	10h	20h
9.6V	133	112	84.0	72.0	53.4	34.9	26.5	20.4	15.8	11.1	9.20	7.50	6.60	4.00	2.10
9.9V	126	110	83.0	71.0	51.9	34.7	26.3	19.8	15.7	10.9	9.10	7.46	6.50	4.00	2.10
10.2V	119	108	82.0	70.0	50.9	34.6	26.1	18.4	15.5	10.7	9.00	7.42	6.50	4.00	2.10
10.5V	112	105	80.0	69.0	50.0	34.5	26.0	17.9	15.1	10.6	8.90	7.38	6.40	4.00	2.10
10.8V	109	97.0	77.0	67.0	49.0	33.2	25.0	17.0	14.6	10.2	8.80	7.30	6.30	4.00	2.10

All mentioned values are average values

LC-P1242P

CHARGING METHOD (25°C)

Trickle use	Control voltage: 13.6V - 13.8V
	Initial current: 6.30A or smaller

CUT-OFF VOLTAGE

Discharge current	2.10A - 8.40A	8.40A - 21.0A	21.0A - 42.0A	42.0A - 84.0A	84.0A - 126A
Cut-off voltage	10.5V	10.2V	9.9V	9.3V	8.7V

INFLUENCE OF TEMPERATURE ON TRICKLE LIFE

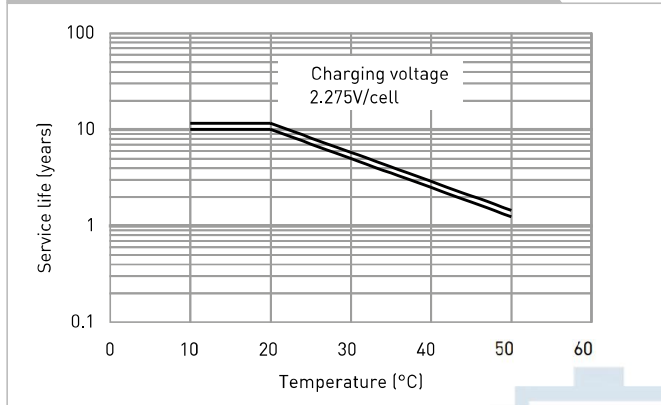

RESIDUAL CAPACITY TEST RESULT

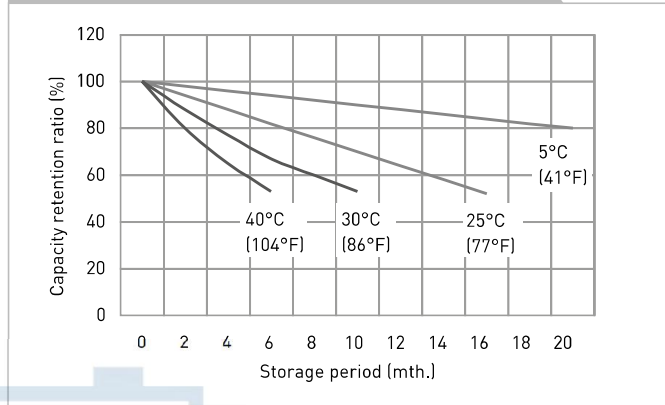

CONSTANT-VOLTAGE CONSTANT-CURRENT CHARGE CHARACTERISTICS FOR TRICKLE USE

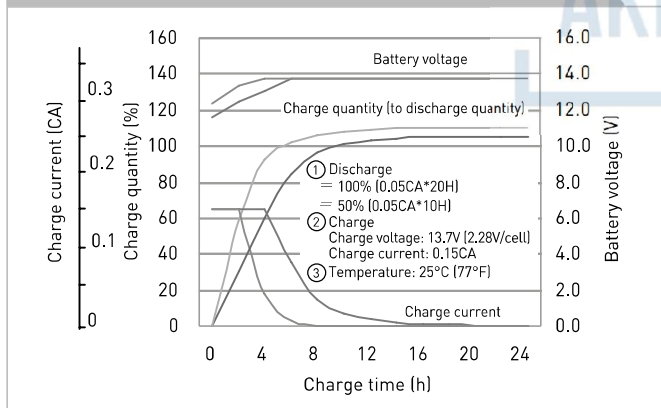

DISCHARGE CAPACITY BY TEMPERATURE AND BY DISCHARGE CURRENT

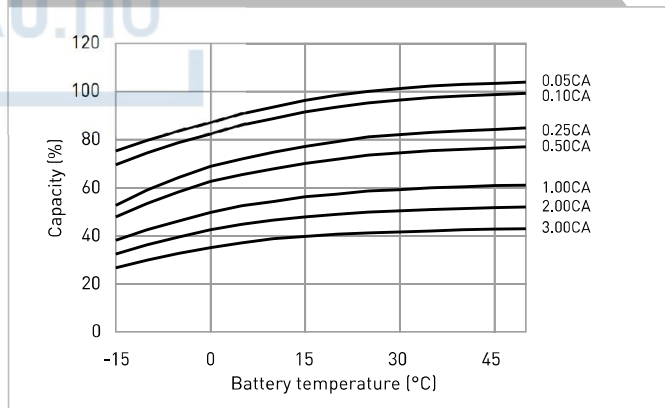

DISCHARGE CHARACTERISTICS

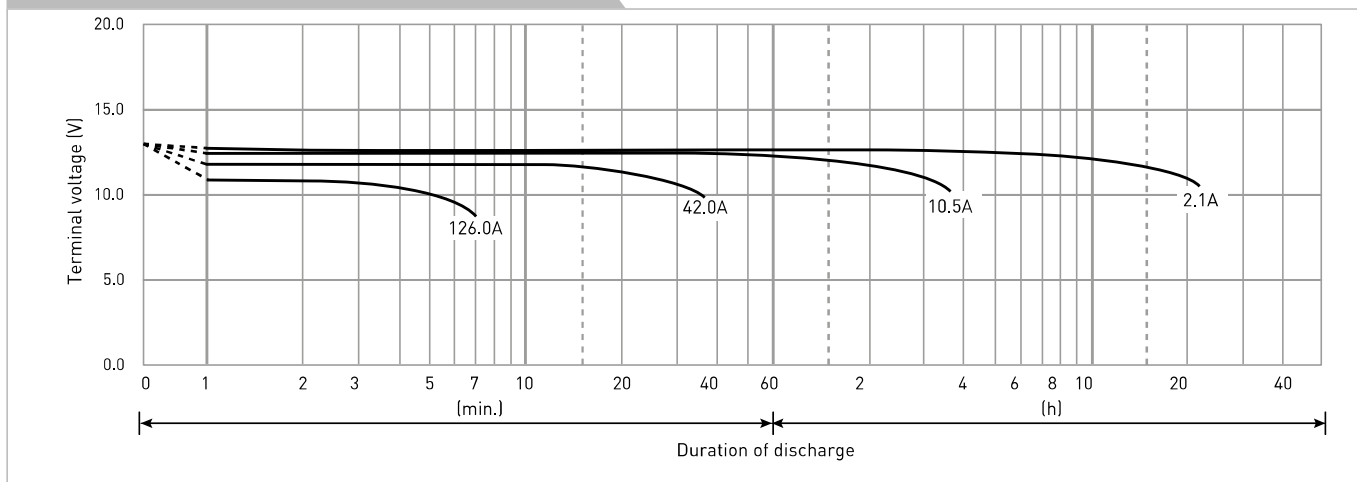

The data in this document are for descriptive purposes only and are not intended to make or imply any guarantee or warranty. Regarding handling and safety please consult our VRLA technical handbook chapter 1.