

LC-XB12100P*1

FOR STANDBY POWER SUPPLIES.
EXPECTED TRICKLE DESIGN LIFE: 10 - 12 YEARS AT 20°C
ACCORDING TO EUROBAT.

DIMENSIONS (MM)

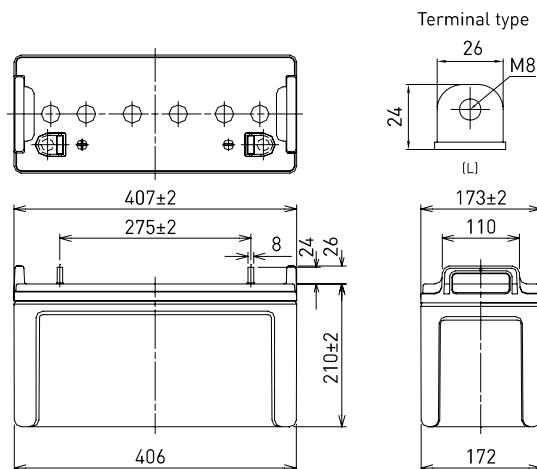

Contents indicated (including the recycle marking, etc.) are subject to change without notice.

Battery case resin: standard (UL94 HB)

SPECIFICATIONS

Name		LC-XB12100P*1
Nominal voltage		12V
Nominal capacity (20 hour rate)		100Ah
Dimensions	Length	407mm
	Width	173mm
	Height	236mm
Approx. mass		36.5kg
Terminal		M8 bolt/nut
Capacity (25°C)	20 hour rate	100Ah
	10 hour rate	98Ah
	3 hour rate	87Ah
	1 hour rate	65Ah
Impedance		Fully charged battery (25°C) 5.0mΩ
Temperature dependency of capacity (20 hour rate)	40°C	102%
	25°C	100%
	0°C	85%
	-15°C	65%
Self-discharge (25°C)	After 3 month	91%
	After 6 month	82%
	After 12 month	64%

DURATION OF DISCHARGE VS. DISCHARGE CURRENT

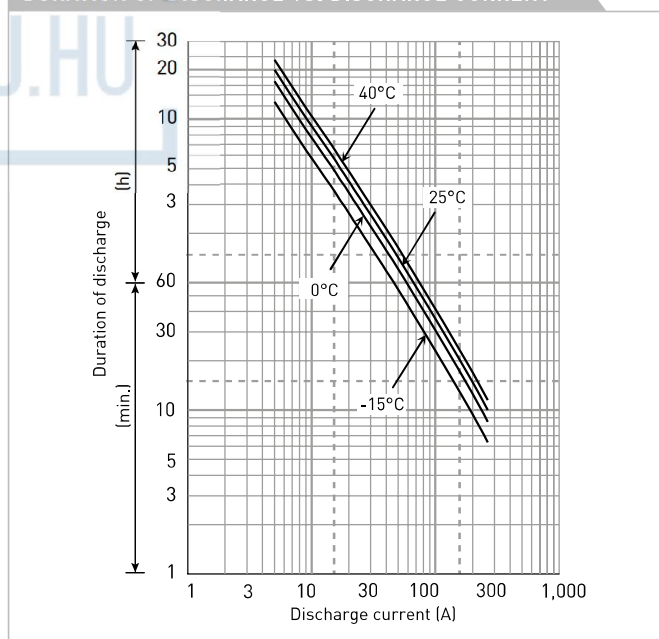

WATT TABLE (25°C)

(Wattage/battery)

Cut-off	5min.	10min.	15min.	20min.	30min.	45min.	1h	1.5h	2h	3h	4h	5h	6h	10h	20h
9.6V	3,504	2,698	2,275	1,776	1,258	904	880	502	411	292	221	188	150	95.0	48.1
9.9V	3,266	2,639	1,973	1,683	1,239	878	795	493	408	287	219	185	149	95.0	48.1
10.2V	2,890	2,534	1,920	1,651	1,229	850	779	489	403	285	217	181	148	94.1	48.1
10.5V	2,498	2,379	1,849	1,601	1,200	738	762	483	398	278	214	180	147	94.1	48.0
10.8V	2,375	2,178	1,756	1,544	1,199	734	758	435	378	272	212	179	144	93.1	47.3

AMPERE TABLE (25°C)

(Ampere/battery)

Cut-off	5min.	10min.	15min.	20min.	30min.	45min.	1h	1.5h	2h	3h	4h	5h	6h	10h	20h
9.6V	365	281	237	185	131	94.2	87.3	52.3	42.8	30.4	23.0	19.5	15.7	9.90	5.01
9.9V	340	275	206	175	129	91.5	78.9	51.3	42.5	29.9	22.8	19.2	15.6	9.90	5.01
10.2V	301	264	200	172	128	88.5	75.5	50.9	42.0	29.7	22.6	18.9	15.5	9.80	5.01
10.5V	260	248	193	167	125	76.9	75.0	50.3	41.5	29.0	22.3	18.8	15.3	9.80	5.00
10.8V	247	227	183	161	125	76.4	74.9	45.3	39.4	28.3	22.0	18.7	15.0	9.70	4.92

All mentioned values are average values



LC-XB12100P*1

CHARGING METHOD (25°C)	
Trickle use	Control voltage: 13.6V - 13.8V Initial current: 15.0A or smaller

CUT-OFF VOLTAGE					
Discharge current	5.00A - 20.0A	20.0A - 50.0A	50.0A - 100A	100A - 200A	200A - 300A
Cut-off voltage	10.5V	10.2V	9.9V	9.3V	8.7V

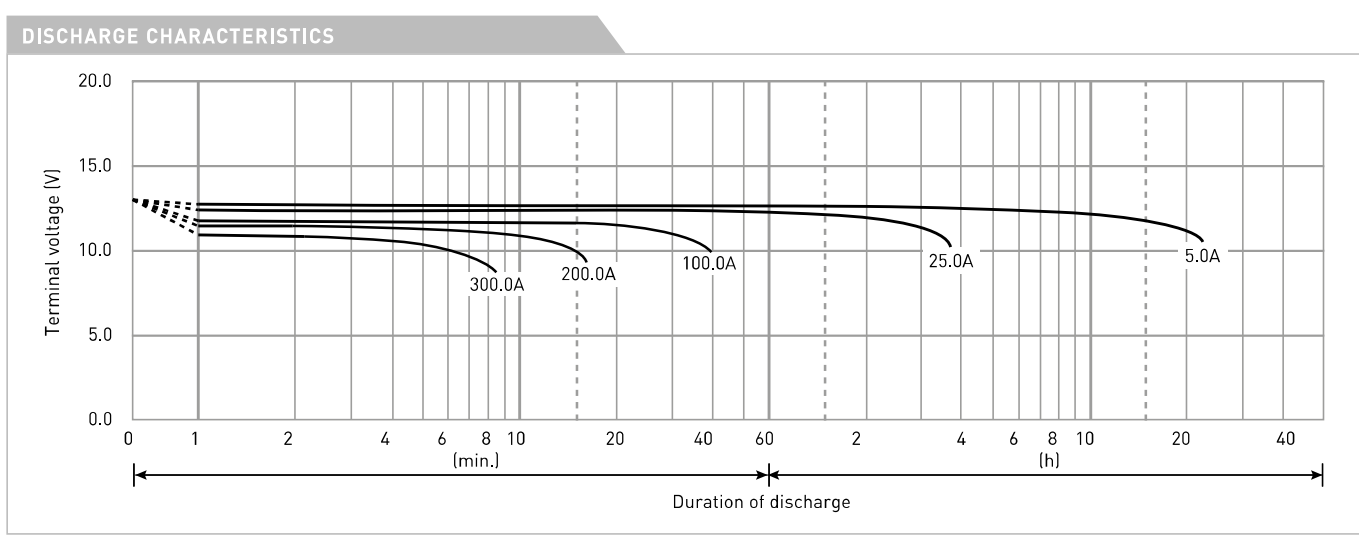
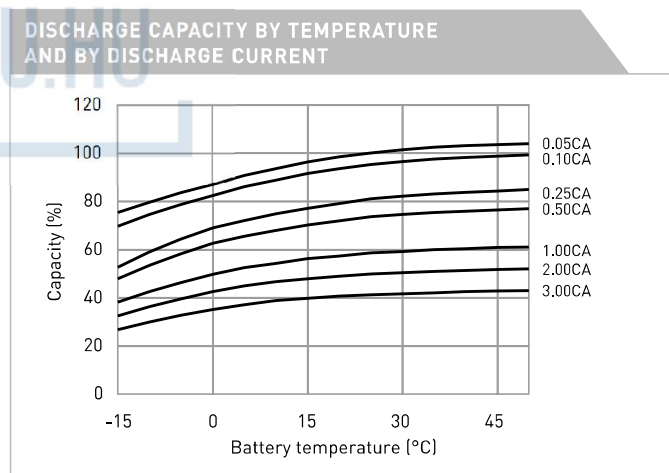
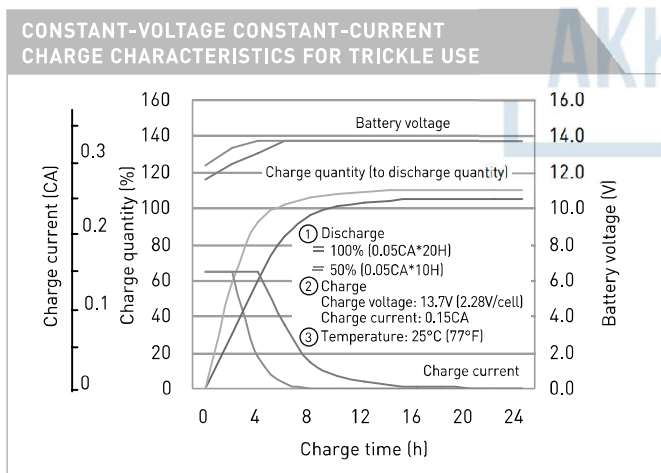
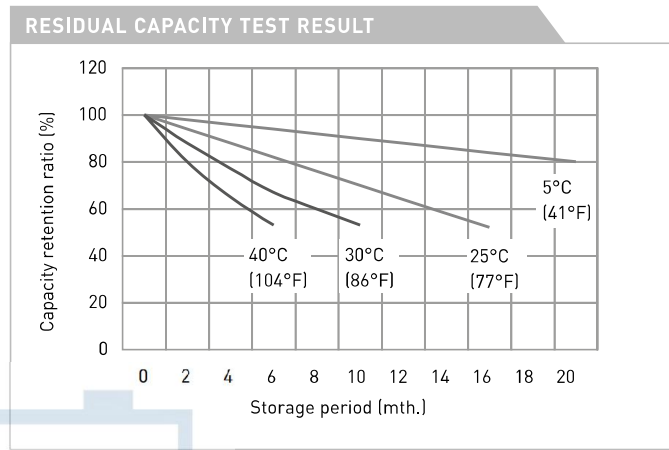
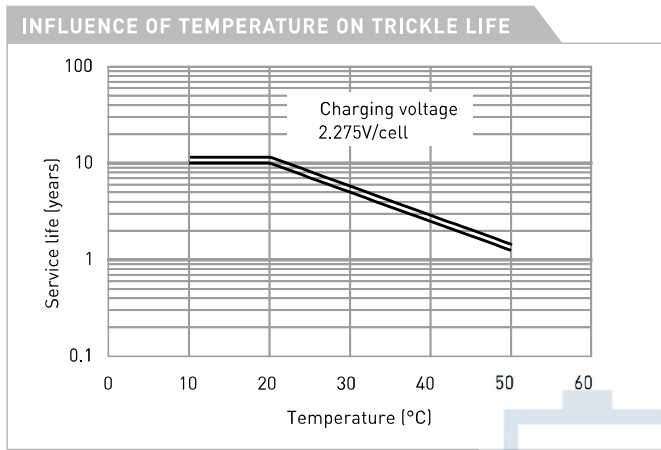

The data in this document are for descriptive purposes only and are not intended to make or imply any guarantee or warranty. Regarding handling and safety please consult our VRLA technical handbook chapter 1.

*1 This battery is also available with a flame retardant battery case resin (UL94 V-0): LC-PB12100P.

