



# RT 1295 (12V9.5Ah)

RT1295 is a general purpose battery with 5 years life in standby service, or more than 260 cycles at 100% D.O.D by cyclic use. As with all Ritar batteries, all RT models are rechargeable, highly efficient, leak proof and maintenance free.



## Specification

Cells Per Unit	6
Voltage Per Unit	12
Capacity	9.5Ah@20hr-rate to 1.75V per cell @25°C
Weight	Approx. 2.8 Kg
Max. Discharge Current	95 A (5 sec)
Internal Resistance	Approx. 15 mΩ
Operating Temperature Range	Discharge: -20°C~60°C Charge: 0°C~50°C Storage: -20°C~60°C
Normal Operating Temperature Range	25°C ±5°C
Float charging Voltage	13.6 to 13.8 VDC/unit Average at 25°C
Recommended Maximum Charging Current Limit	2.85 A
Equalization and Cycle Service	14.4 to 15.0 VDC/unit Average at 25°C
Self Discharge	RITAR batteries can be stored for more than 6 months at 25°C. Please charge batteries before using. For higher temperature, the time interval will be shorter.
Terminal	Faston tab 250(F2)
Constainer Material	A.B.S. (UL94-HB) Flammability resistance of UL94-V2 can be available upon request.



## Dimensions

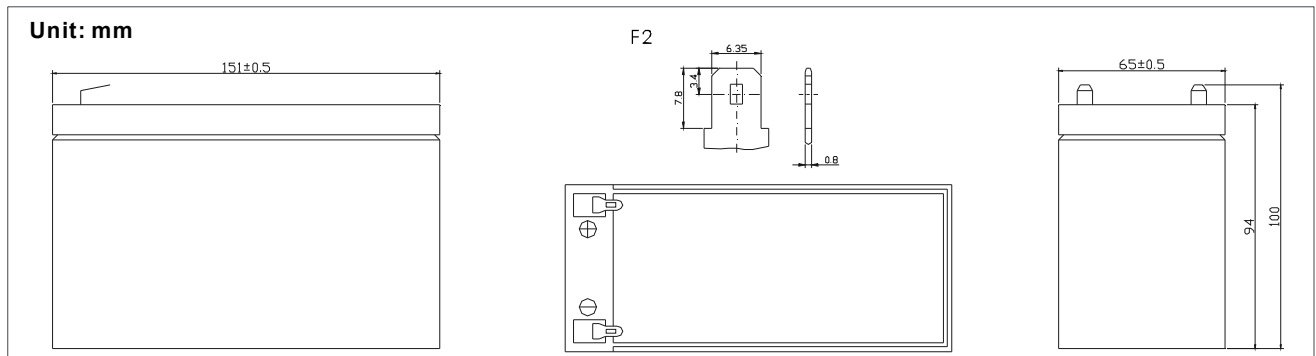

### Constant Current Discharge Characteristics Unit: A(25°C)

F.V/Time	5MIN	10MIN	15MIN	30MIN	1HR	2HR	3HR	4HR	5HR	8HR	10HR	20HR
1.60V	39.4	26.4	20.3	11.1	6.59	3.95	2.43	2.00	1.61	1.18	0.93	0.52
1.67V	36.9	24.6	19.0	11.0	6.56	3.92	2.42	1.99	1.60	1.18	0.92	0.50
1.70V	34.9	23.8	18.6	10.9	6.51	3.91	2.41	1.98	1.59	1.18	0.91	0.49
1.75V	31.5	22.3	17.6	10.6	6.41	3.87	2.40	1.97	1.58	1.18	0.90	0.48
1.80V	28.2	20.8	16.7	10.4	6.32	3.80	2.38	1.96	1.57	1.17	0.88	0.46
1.85V	24.8	19.3	15.7	10.1	6.23	3.74	2.37	1.95	1.56	1.17	0.87	0.45

### Constant Power Discharge Characteristics Unit: W(25°C)

F.V/Time	5MIN	10MIN	15MIN	30MIN	1HR	2HR	3HR	4HR	5HR	8HR	10HR	20HR
1.60V	76.0	49.4	40.1	22.3	13.2	7.89	4.85	3.97	3.77	2.37	1.85	1.04
1.67V	71.3	47.5	38.1	21.9	13.1	7.85	4.85	3.96	3.74	2.37	1.83	1.00
1.70V	69.8	46.1	37.2	21.8	13.1	7.83	4.84	3.96	3.73	2.35	1.81	0.98
1.75V	63.1	44.2	35.3	21.3	12.9	7.70	4.81	3.93	3.72	2.34	1.80	0.94
1.80V	56.4	41.3	33.3	20.8	12.7	7.60	4.77	3.90	3.71	2.33	1.77	0.91
1.85V	49.6	38.5	31.4	20.3	12.5	7.49	4.73	3.88	3.71	2.33	1.74	0.88

All mentioned values are average values.

# RT 1295

# 12V9.5Ah



## Temperature effects curve

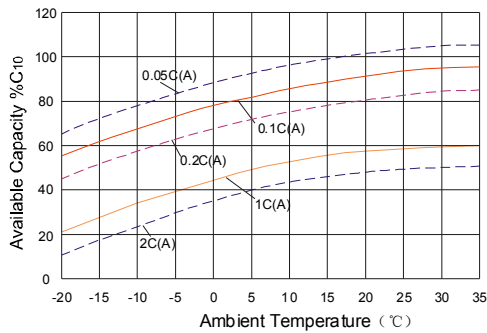

## Storage characteristic

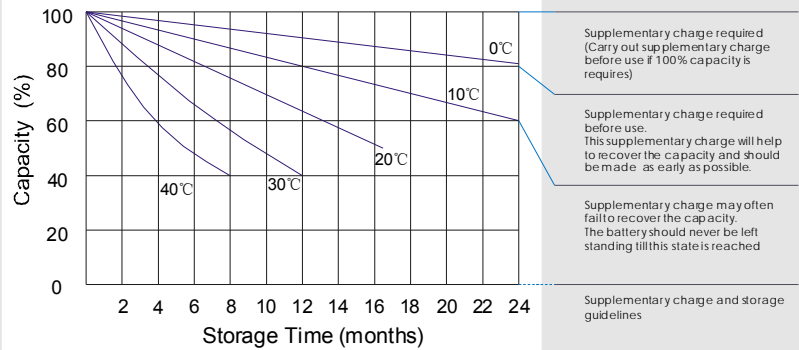

## Life characteristics of cyclic use

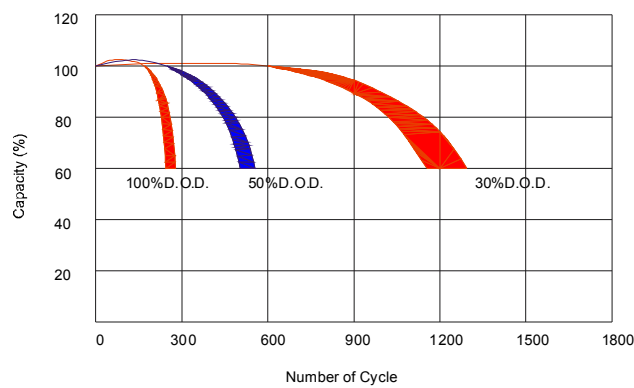

## Effect of temperature on long term float life

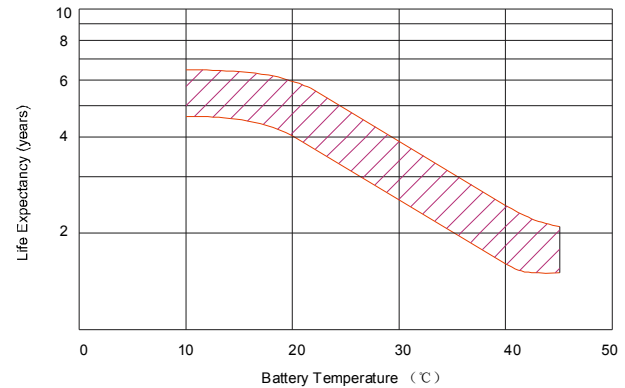

## Charge characteristic Curve for standby use

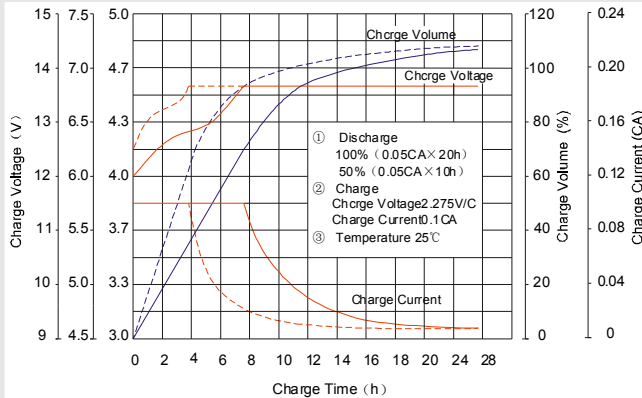

## Discharge characteristic Curve

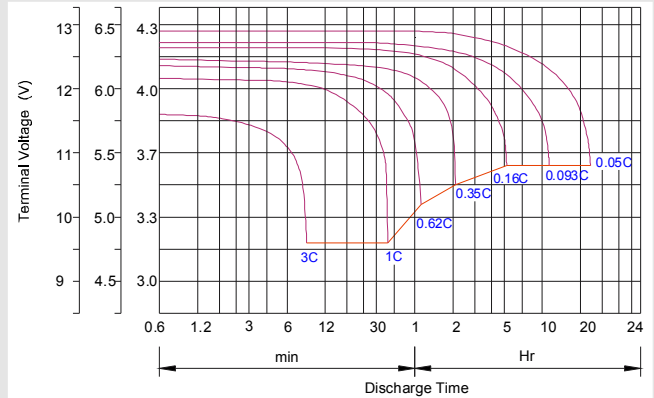

## Charging Procedures

Application	Charge Voltage (V)			Max. Charge Current
	Temperature	Set point	Allowable range	
Cycle Use	25°C	14.7	14.4~15.0	0.3C
Standby	25°C	13.7	13.6~13.8	0.3C

## Discharge Current VS. Discharge Voltage

Final Discharge Voltage V/cell	1.75V	1.70V	1.60V
Discharge Current (A)	(A) ≤ 0.2C	0.2C < (A) < 1.0C	(A) ≥ 1.0C

Charge the batteries at least once every six months, if they are stored at 25°C.

Charging Method:

Constant Voltage	14.4~15.0V, 5~11h, Max. Current 0.1CA
Constant Current	0.1CA x 5h
Fast	0.3CA x 1.7h

## Charging Procedures(6V series)

Application	Charge Voltage (V)			Max. Charge Current
	Temperature	Set point	Allowable range	
Cycle Use	25°C	7.35	7.25~7.45	0.3C
Standby	25°C	6.85	6.8~6.9	0.3C

SHEN ZHEN RITAR POWER CO.,LTD.

Rm2201, Tian'an Cyber-Times Building, Tian'an Park, Futian District, ShenZhen, China(518040)  
Tel: +86-755-8347 5380 Fax: 86-755-8347-5180  
URL: [www.ritarpower.com](http://www.ritarpower.com)